

# Inspiration **SILVAN**

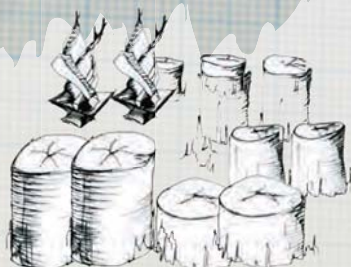

Materialer og værktøj: æblekasser

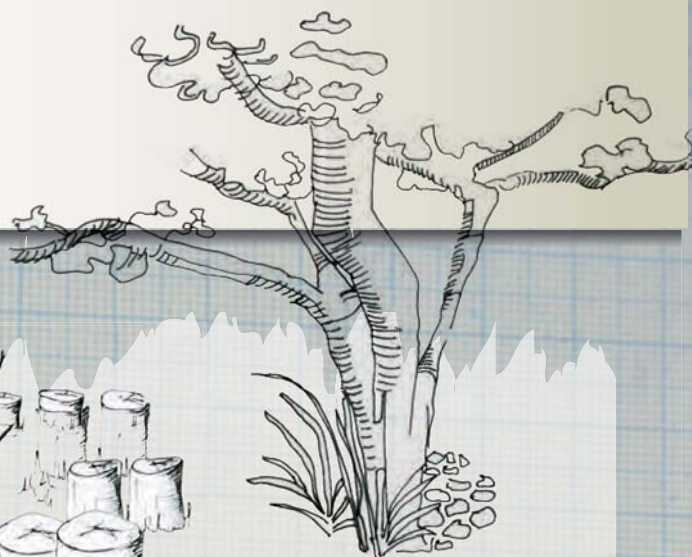

**SILVAN**

# Inspiration SILVAN

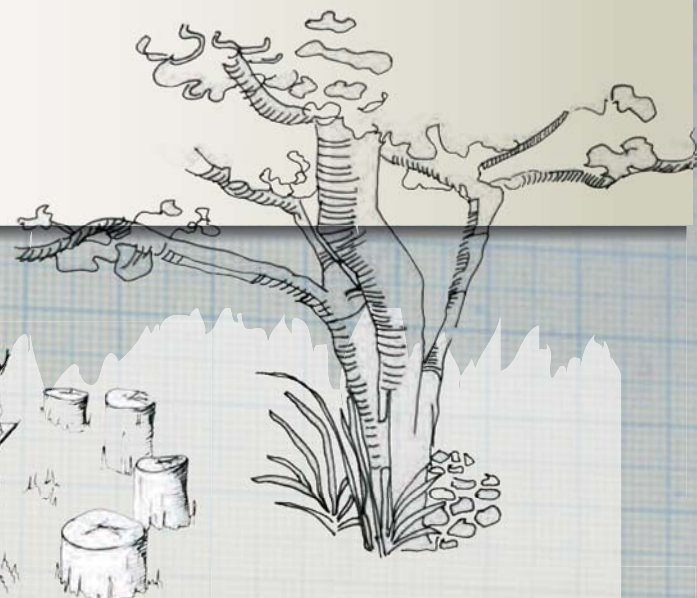

## Materialeliste: æblekasser

Sider

Høvlet forskalling  
4 stk 60 cm

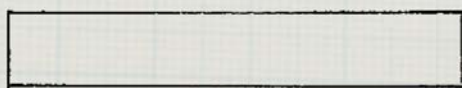

D

Ender

Høvlet forskalling  
4 stk 24 cm  
4 stk 30 cm

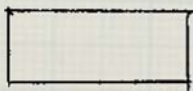

A

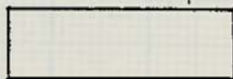

B

Bund

Høvlet forskalling  
3 stk 57

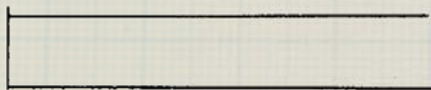

**SILVAN**

# Inspiration **SILVAN**



Teknisk tegning: skabelon til æbelkasser

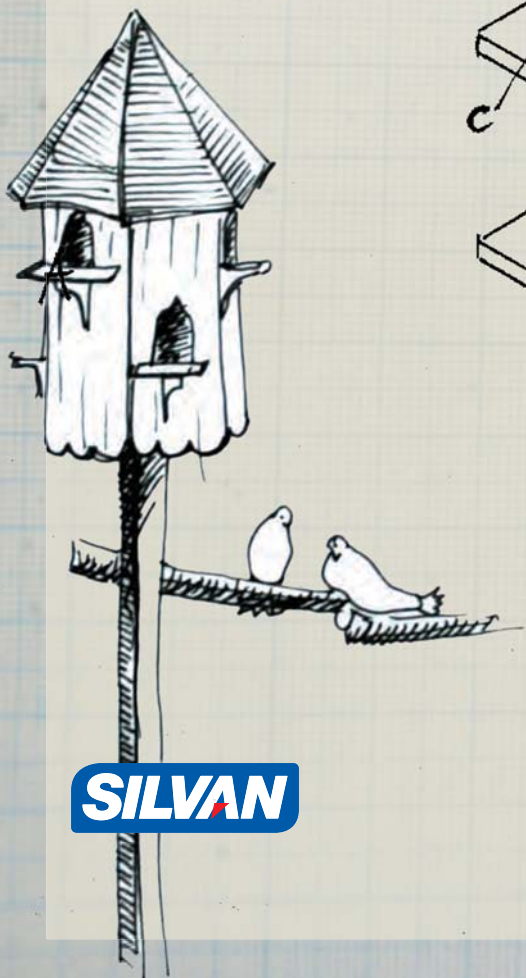
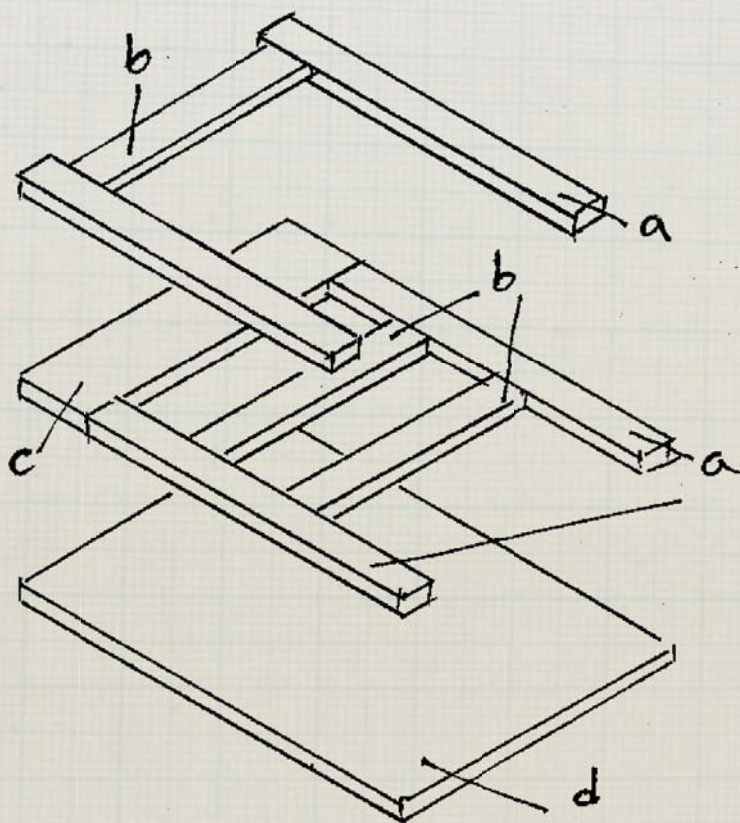

**SILVAN**



# Inspiration **SILVAN**



Teknisk tegning: æblekasser

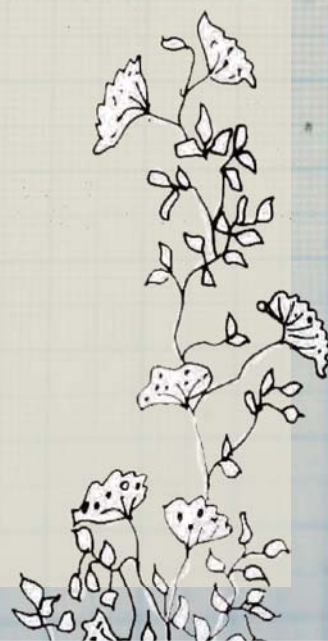
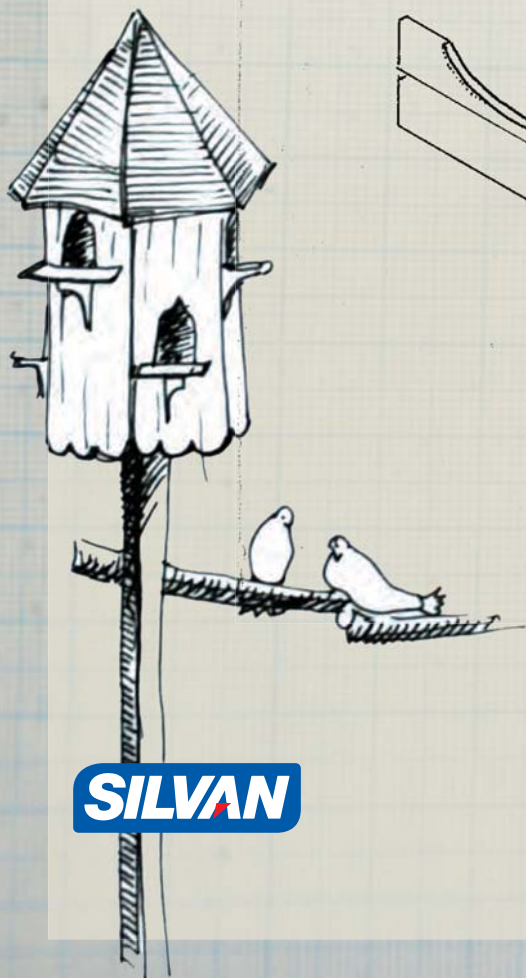
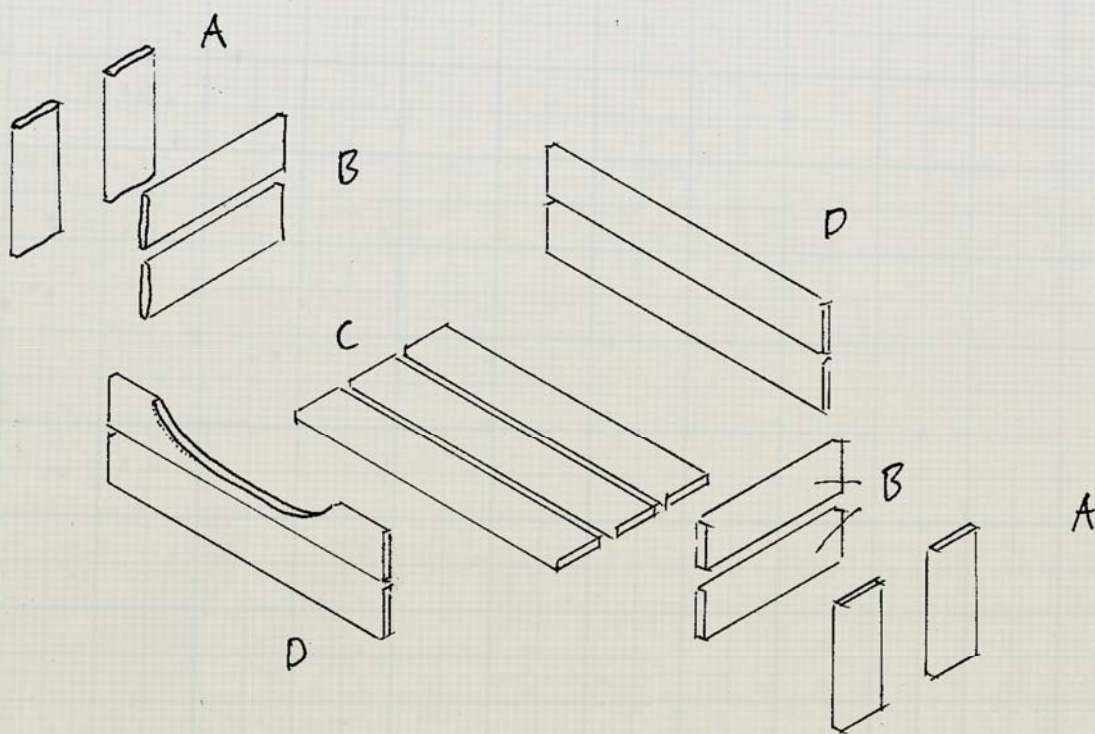

**SILVAN**

# Inspiration SILVAN

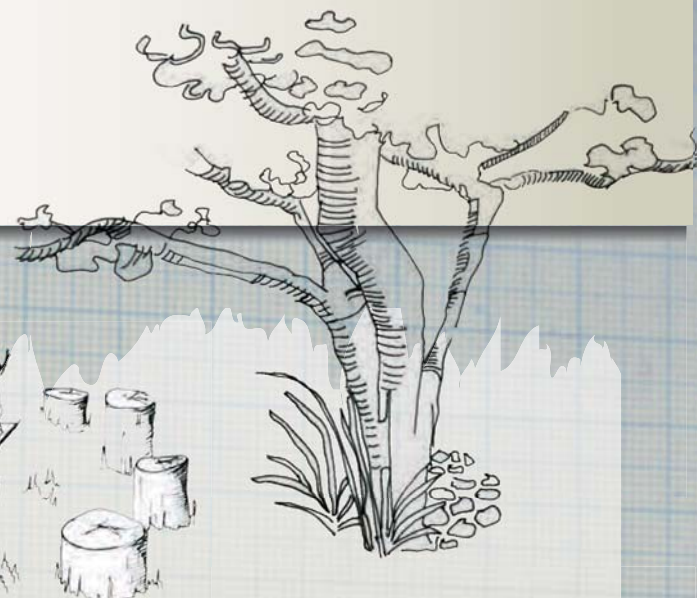

## Materialeliste: æblekasser skabelon

4 stk 4,5x45 cm

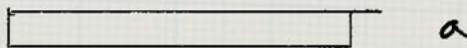

3 stk 4,5x30 cm

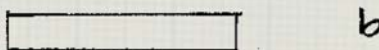

1 stk 10x39 cm

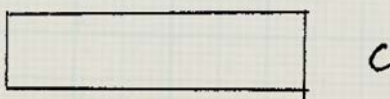

1 stk 55x39 cm

